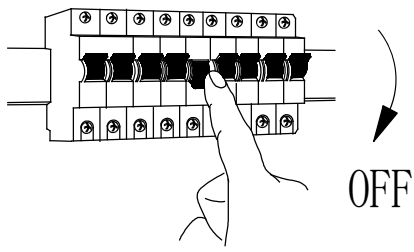
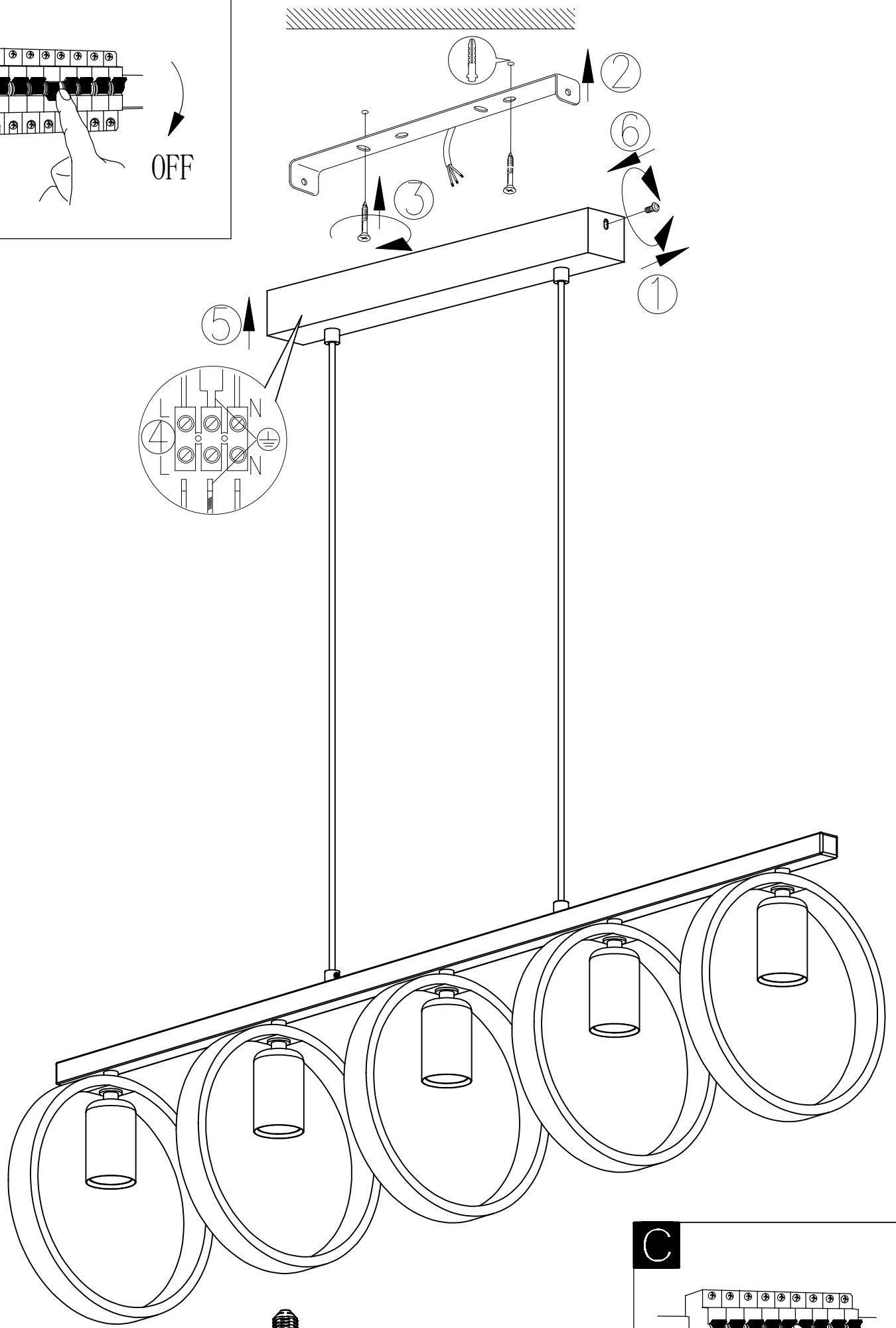
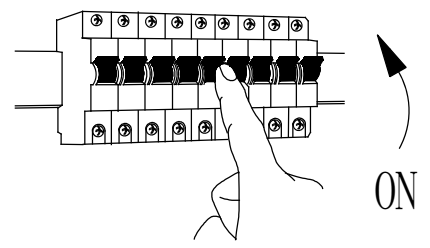

A**B****C**

BLA43552
www.eglo.com