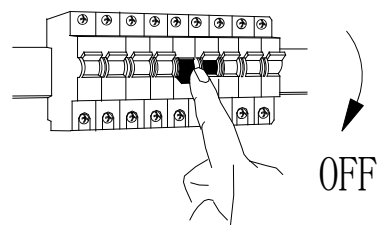
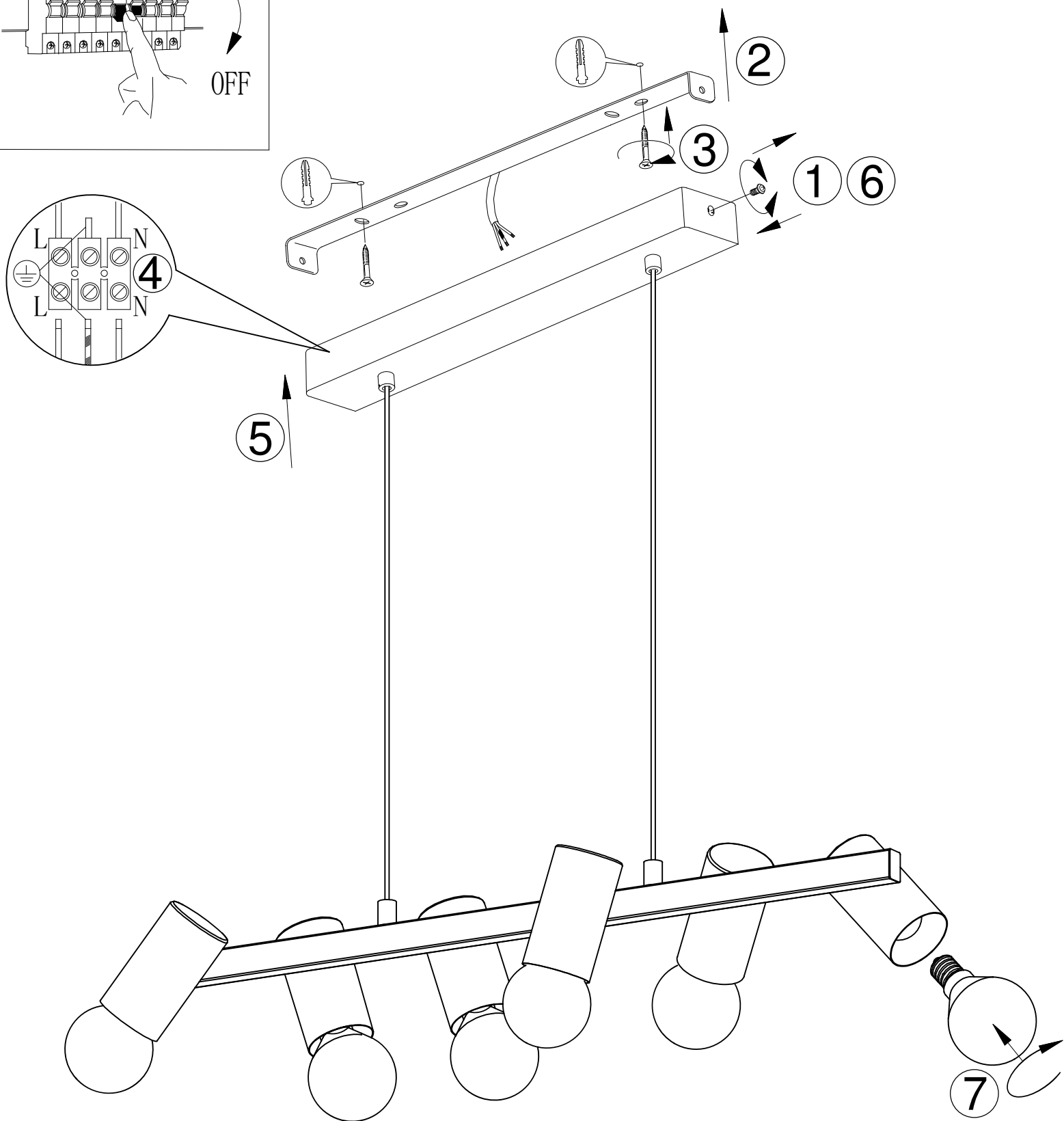
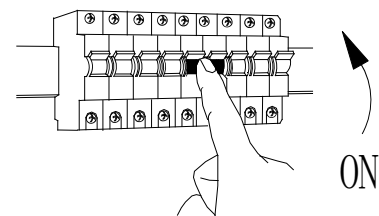

**A****B****C**

BLA98687

WWW.Eglo.com