



ENG

TL-LD810

VIZ300™

TL-LD820

VIZ450™

Manual

Before using the light, read this manual thoroughly and keep it for future reference. Do not use the product in any application or method not described in this manual.

Design Pat. Pending
Copyright © 2020 CATEYE Co., Ltd.
TL-LD810/820-201223 1

⚠ WARNING!!! (Risk of death; Prevention of accidents)

- To prevent accidents and to ensure safe riding, make sure the light is securely attached to the bracket and it is functioning properly before the ride. Do not use a damaged ladder rubber band.
- Always pay attention to the remaining battery power by checking the indicator periodically when using.
- Do not disassemble or modify the light or any of the included items.

⚠ CAUTION! (Prevention of injury, damage, or property damage)

- Stop your bicycle to operate the switch.
- Do not place it within children's reach.
- This device is rated IPX4 based on JIS C0920. Do not immerse the device in water. Doing so may cause a malfunction. Wipe off any moisture after using the device in rainy weather.
- Do not subject the light to strong vibrations, impacts, or excessive force. Discontinue use if any abnormality occurs.
- Do not charge the battery in any way or at any voltage other than that specified. Do not short-circuit the battery.
- Do not drop the light into a fire or heat the light.
- If the light unit or parts become dirty with mud, etc., clean with a soft cloth which is moistened with mild soap. Never apply paint thinner, benzene or alcohol; damage will result.

⚠ LITHIUM-ION BATTERIES

Cautions for charging and usage:

- We recommend using 500+mAh (USB2.0) USB battery charger.
- Before charging, be sure that no dust or other foreign objects attach to the USB plug.
- Do not subject the light to vibrations while charging.
- When your PC is in sleep state, the unit cannot be charged.
- Once charging is complete, be sure to disconnect the USB plug.
- Charging time is approximate values, and will vary depending on the environmental and usage conditions.
- Charging, discharging, and storing in high temperatures will cause the rechargeable battery to deteriorate faster. Do not place the light inside a vehicle or near a heater. Make sure to charge only when the ambient temperature is between 5 and 40°C.
- If the illumination time is significantly reduced even after proper charging, the rechargeable battery may be nearing the end of its service life.

Cautions on storage:

- If the device will not be used for a long period of time, store it in a location that is not too hot or too humid.
- Charge the battery for about 30 minutes every 6 months.

Cautions for dispose:

When disposing of the light unit, remove the internal rechargeable battery and dispose of it according to local regulations.

Included Items



Light unit



Bracket (SP-15)

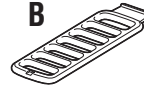

Ladder rubber band



Bracket rubber pad

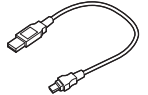

USB cable (MICRO USB)

1 HOW TO CHARGE

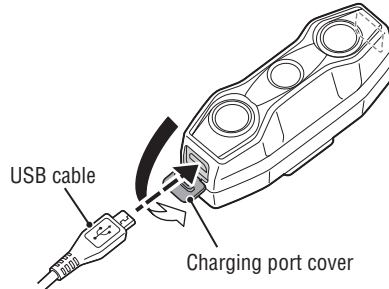

To PC or USB battery charger

CAUTION!:

- Always charge the product before use.
- Once charging is completed, securely close the charging port cover.

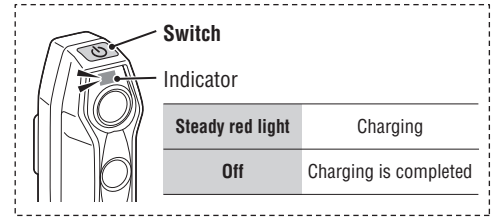

Standard charging time

Viz300 **Approx. 3 hours** (0.5A)

Viz450 **Approx. 3.5 hours** (0.5A)

2 SWITCH OPERATION



* When turning the light on, it lights up in the mode that was used last time. (Mode memory function)

Switching the lighting mode

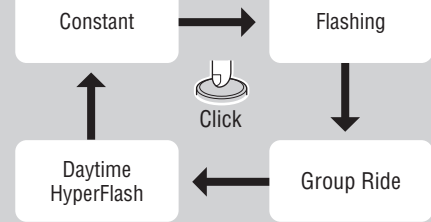

Automatic battery-saving function:

When the remaining battery power gets low, the indicator starts flashing and the lighting mode changes to power-save flashing mode (where the LEDs on both ends of the unit flash alternately). Charge the product as soon as possible.

* Run time is approximately 1 hour in power-save flashing mode.

3 HOW TO MOUNT TO A BICYCLE

Attach the light securely in the mounting position.

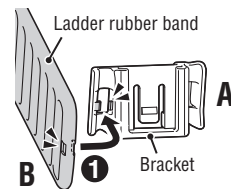

Attach the ladder rubber band (B) to the bracket (A).

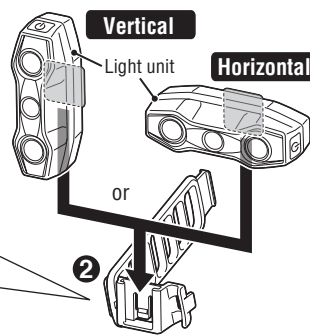

Mount the light unit vertically or horizontally.

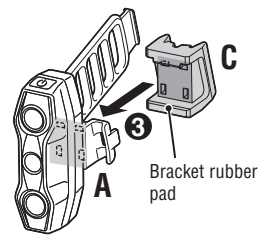

Attach the bracket rubber pad (C) aligning it with the protrusion on the back of the bracket (A).

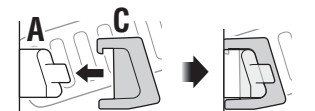

Seat post/stay
Ø21.5 – 32 mm

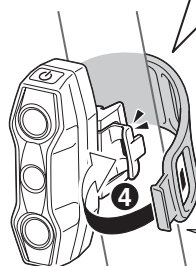

* The light can be mounted on aero seat posts with an outer circumference of approx. 130 mm.

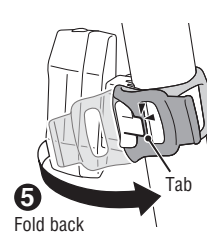

Fold back any excess band and hook it on the tab.

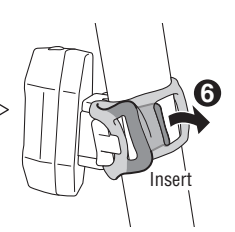

Insert the tip of the band into the gap.

SPECIFICATIONS

Viz300

Battery	Li-ion 3.7 V 800 mAh
Operating time	
• Constant	Approx. 5 hours
• Flashing	Approx. 45 hours
• Group Ride	Approx. 8 hours
• Daytime HyperFlash	Approx. 10 hours
Standard charging time (0.5 A)	Approx. 3 hours
Temperature range	
• Charging	41°F – 104°F (5°C – 40°C)
• Operating	14°F – 104°F (-10°C – 40°C)
Waterproof	IPX4
Recharge/discharge number of times	About 300 times (until the rated capacity drops to 70%)
Dimensions / Weight	2-31/32" x 63/64" x 1-11/32" (75.5 x 25 x 34 mm) / 1.66 oz (47 g)

* The specifications and design are subject to change without notice.

Viz450

Battery	Li-ion 3.7 V 1000 mAh
Operating time	
• Constant	Approx. 5 hours
• Flashing	Approx. 65 hours
• Group Ride	Approx. 10 hours
• Daytime HyperFlash	Approx. 14 hours
Standard charging time (0.5 A)	Approx. 3.5 hours
Temperature range	
• Charging	41°F – 104°F (5°C – 40°C)
• Operating	14°F – 104°F (-10°C – 40°C)
Waterproof	IPX4
Recharge/discharge number of times	About 300 times (until the rated capacity drops to 70%)
Dimensions / Weight	2-31/32" x 63/64" x 1-11/32" (75.5 x 25 x 34 mm) / 1.59 oz (45 g)

* The specifications and design are subject to change without notice.

Standard accessories

5342490

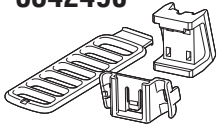

Bracket
(SP-15)

5342730

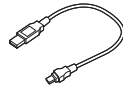

USB cable
(MICRO USB)

Optional accessories

5342460

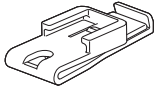

Clip
(C-2)

LIMITED WARRANTY

2-year Warranty: Light unit only (excludes battery deterioration)

CatEye products are warranted to be free of defects from materials and workmanship for a period of 2 years from original purchase. If the product fails to work during normal use, CatEye will repair or replace the defect at no charge. Service must be performed by CatEye or an authorized retailer. To return the product, pack it carefully and enclose the warranty certificate (proof of purchase) with instruction for repair. Please write or type your name and address clearly on the warranty certificate. Insurance, handling and transportation charges to CatEye shall be borne by person desiring service.

For UK and REPUBLIC OF IRELAND consumers, please return to the place of purchase. This does not affect your statutory rights.

CAT EYE CO., LTD.

2-8-25, Kuwazu, Higashi Sumiyoshi-ku, Osaka 546-0041 Japan

Attn: CATEYE Customer Service Section

Phone : (06)6719-6863

Fax : (06)6719-6060

E-mail : support@cateye.co.jp

URL : www.cateye.com

[For US Customers]

CATEYE AMERICA, INC.

2825 Wilderness Place Suite 1200, Boulder CO 80301-5494 USA

Phone : 303.443.4595

Toll Free : 800.5.CATEYE

Fax : 303.473.0006

E-mail : service@cateye.com